

SAGINAW CONTROL & ENGINEERING

SCE-90XMC2D24

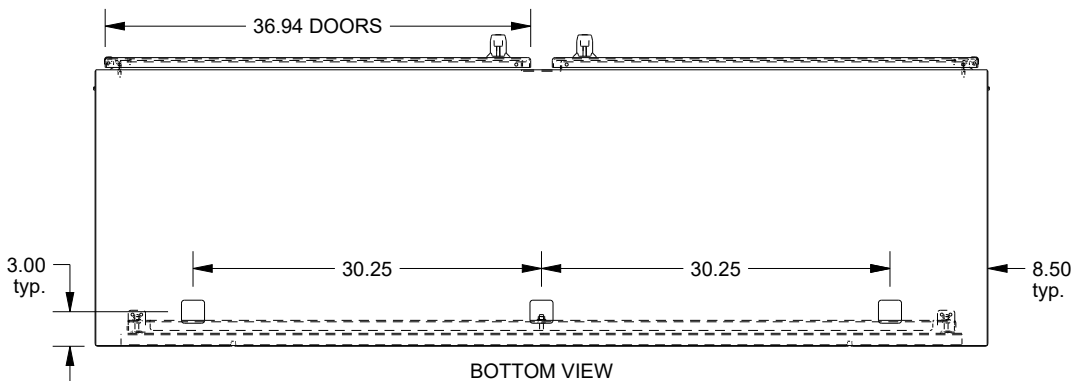
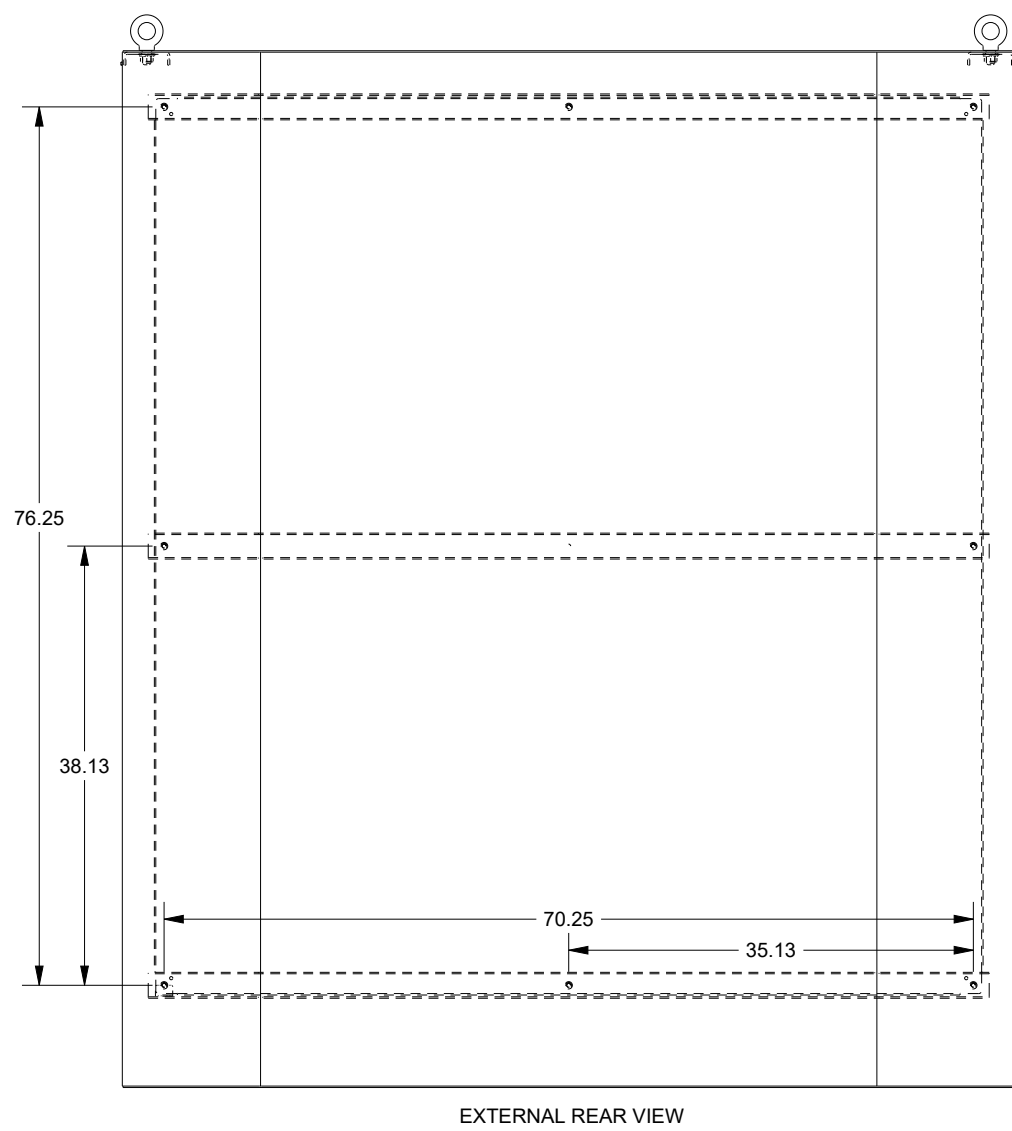
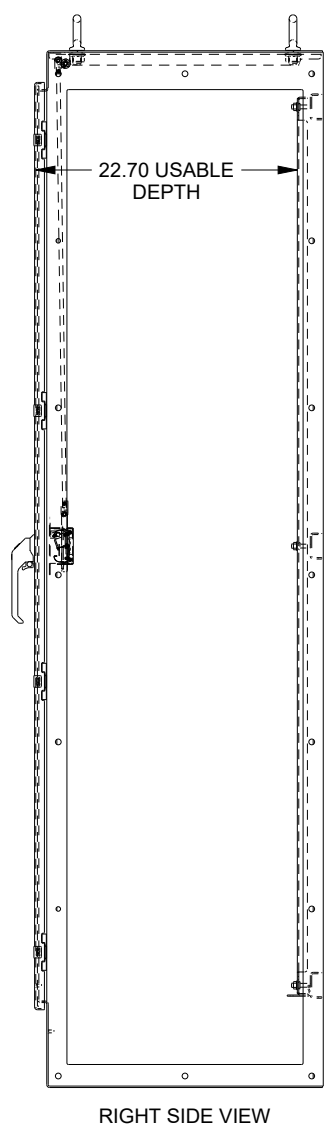
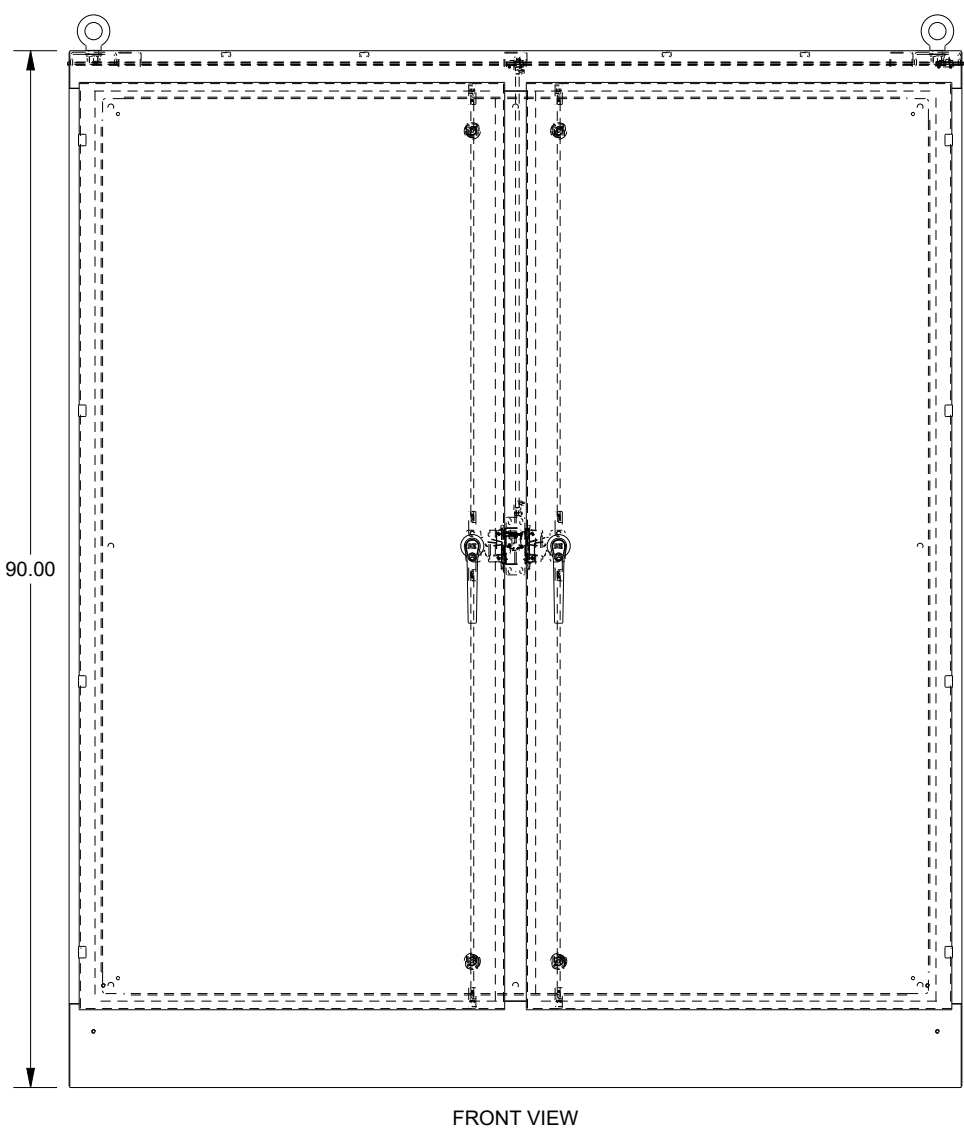
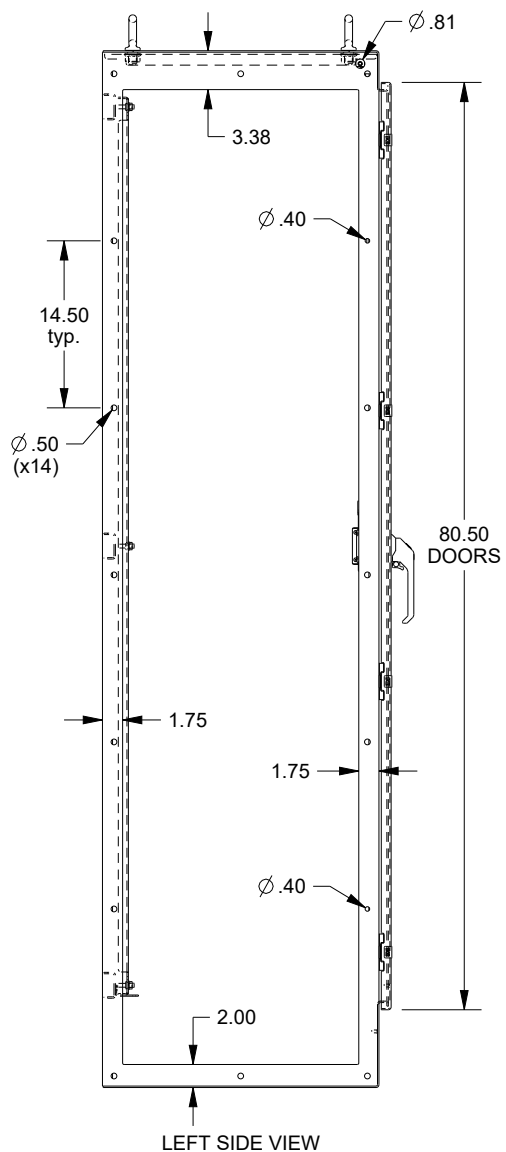
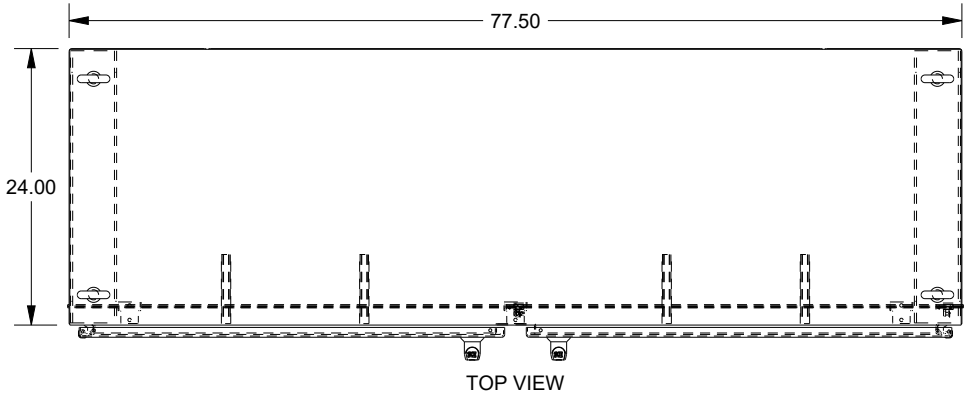

WASH SYSTEM 2" SQUARE DRAIN HOLES IN THE BOTTOM WITH UL APPROVED HOLE SEALS PROVIDED